

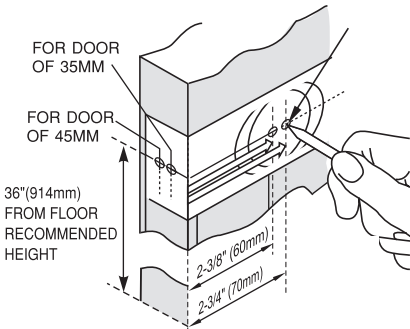

BETTER HOME PRODUCTS

INSTRUCTION FOR INSTALLING LOCKSET

1. MARK DOOR



Place template on outside of door with height center line 36" from floor, Mark both holes as shown.

2. DRILL TWO HOLES

Drill a 2-1/8"(54mm) hole through face of door. Drill 1"(25mm) hole straight into edge of door. Mortise for latch face until flush and install latch bolt.

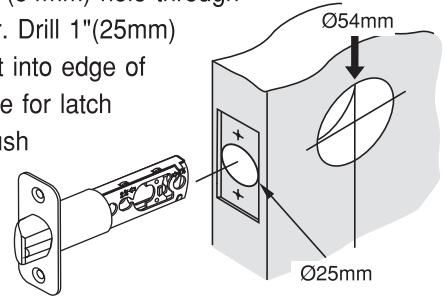

3. INSTALL STRIKE ON DOOR JAMB

Transfer the vertical center line and the height line to the jamb. Drill 1-1/16"(27mm) hole 7/8" (22mm) deep. Cut out jamb until flush and install strike, setting the screw hole on the center line. (Adjustable tang permits bending in or out to eliminate excessive looseness between door and stop).

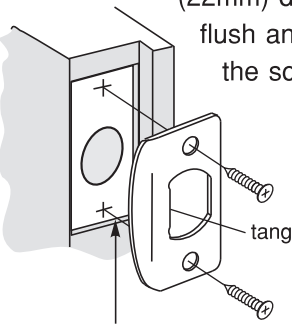

4. INSTALL OUTSIDE KNOB(OR LEVER)

Insert outside knob (or lever) with spindle into latch, making certain that stems are positioned correctly through latch hole. Press flush against door.

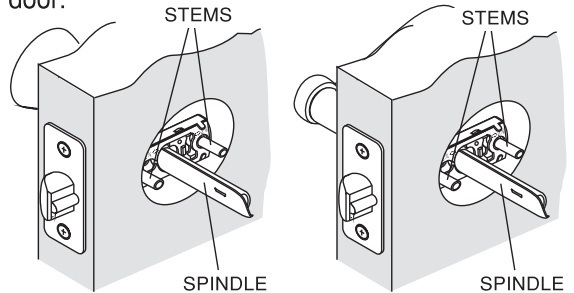

5. INSTALL INSIDE ASSEMBLY

Remove inside knob(or lever) and rose slip inside assembly over spindle. Insert screws through mounting plate and tighten evenly until snugly secured.

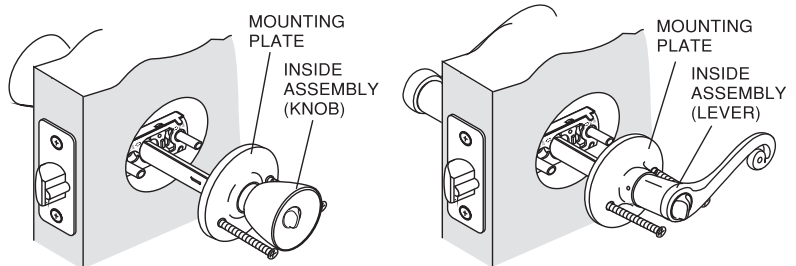

Instruction For Adjustable Backset

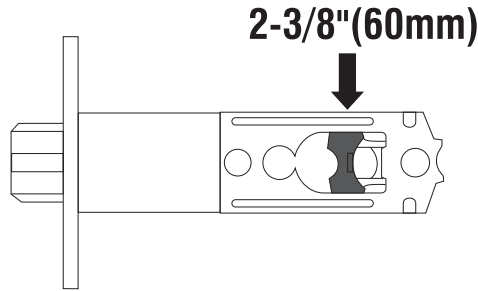

The latch is set 2-3/8" (60mm) To adjust to 2-3/4" (70mm), Slide Spindle cam to 2-3/4" markings.

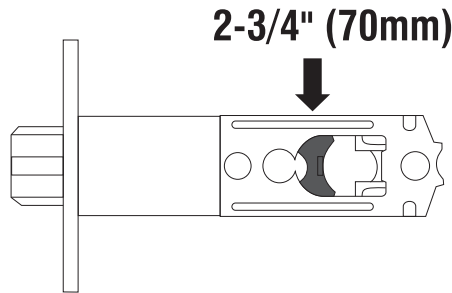

TEMPLATE

1 FOLD HERE ON DOOR EDGE

IMPORTANT !
PLACE TEMPLATE FOLD ON LOW EDGE OF DOOR BEVEL

2 MARK CENTER OF 1-3/4" (45mm) THICK DOOR FOR 1" (25mm) HOLE
MARK CENTER OF 1-3/8" (35mm) THICK DOOR FOR 1" (25mm) HOLE

5 DRILL 1" (25mm) HOLE IN CENTER OF DOOR EDGE FOR LATCH

CAUTION !
Check backset required for lock before drilling 2-1/8" (54mm) hole.
Backset: is length from center edge of door to center of 2-1/8" (54mm) hole.

2 3/4" (70mm) BACKSET
2 3/8" (60mm) BACKSET

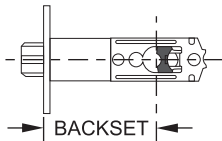

3 MARK CENTER OF 2-1/8" (54mm) HOLE ON DOOR FACE

4 DRILL 2-1/8" (54mm) HOLE

Recommended centerline is 36" (914mm) from floor.